

VANITY CABINET + MIRROR
VANITY SET: LV1-36

INSTALLATION INSTRUCTIONS

**READ ALL INSTRUCTIONS BEFORE UNPACKING THE PRODUCT****CAUTION!****TWO PERSON
LIFT REQUIRED****2 PEOPLE ARE REQUIRED TO LIFT AND DURING
ENTIRE INSTALLATION OF THIS PRODUCT****INSTALLATION OF LESSCARE PRODUCTS BY AN
INEXPERIENCED INSTALLER MAY RESULT
PERSONAL INJURY OR DEATH!****INSTRUCTIONS THAT, IF IGNORED COULD RESULT IN DEATH OR SERIOUS INJURY CAUSED BY INCORRECT HANDLING
OR INSTALLATION OF THE PRODUCT. THESE INSTRUCTIONS MUST BE OBSERVED FOR SAFE INSTALLATION.**

LessCare reserves the right to change, update, modify, alter, redesign this manual/product or its policies without prior notice!
It is your responsibility to visit website to download or contact customer service for the most updated version of the installation instructions.

LessCare shall not be liable for any injuries or property damages in connection with this product during installation or use of this product!

LessCare products must be installed by a fully insured and licensed plumber only. Installation of any LessCare product by anyone other than fully insured and licensed plumber shall void limited warranty. LessCare recommends that such licensed plumber have experience in the installation of products.

Limited warranty is void on any commercial installation

LessCare is not responsible for local code compliance for this product. Building and plumbing codes may vary from state-to-state in accordance to your location. LessCare is not responsible for providing any compliance certifications.

LessCare is not responsible to provide any type of certifications for this product

Under no circumstances LessCare shall not be liable for any and all incidental damages sustained in connection with this product

Neither manufacture, nor distributor, nor retailer is responsible for water damage or flood caused due to use of this product.

Under no circumstances LessCare shall not be liable for any and all fees, cost of installation/reinstallation/removal, subsequent damage or transportation in case of the product defect

PRODUCT CARE & MAINTENANCE

Regular and proper care of the product will help to keep its appearance like new for a long time.
Follow these simple steps and rules to take care of your product.

- Use only mild detergents such as soapy water to clean the surface of the product
- Absolutely avoid using cleaning products that contain bleach or ammonia
- Only use a soft cloth material to wipe a surface of the vanity cabinets.
- Never use steel, wool, or wired brushes as they will permanently scratch the surface
- Prolonged exposure of a direct sunlight may cause discoloration of the wood finish surface

PRODUCT PACKAGE COMPONENTS/TOOLS REQUIRED

VANITY COMBINATION
MAIN COMPONENTS

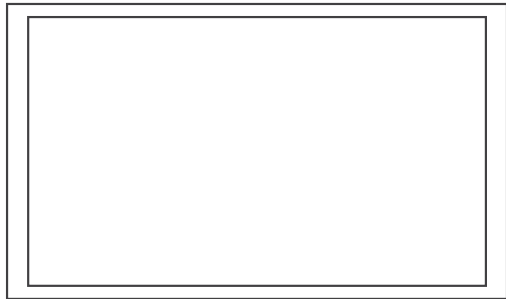

x 1

LV1-3
Wall Mount Mirror

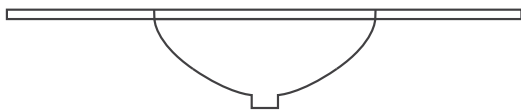

x 1

LV1-2
Tempered Glass Basin

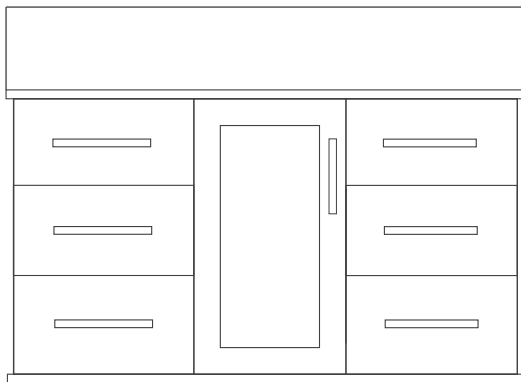

x 1

LV1-1
Vanity Base Cabinet

INSTALLATION ACCESSORIES



x 2

LV1-4
Wall Anchors



x 2

LV1-5
Screws 1 1/4"



x 2

LV1-6
Glass Top Leg



x 4

LV1-7
Base Leg

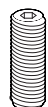

x 4

LV1-8
Set Screws

P-TRAP AND POP AND POP-UP
INSTALLATION DIAGRAM

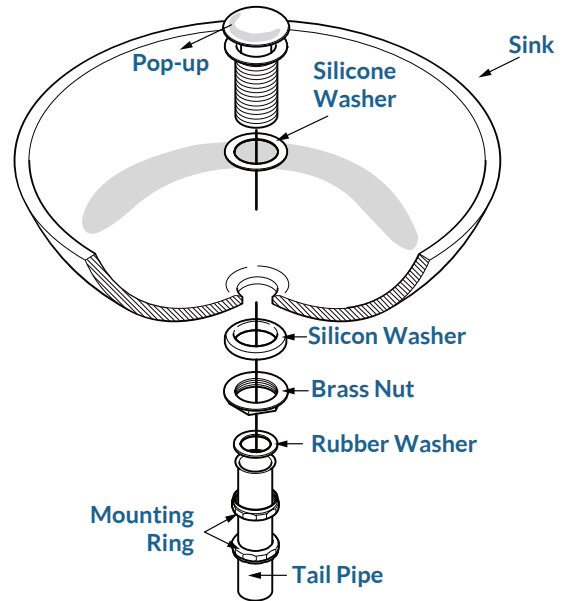

TOOLS REQUIRED FOR INSTALLATION
(NOT INCLUDED)



Safety Glass

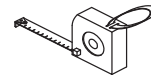

Tape Measure



Pencil/Marker



Silicone

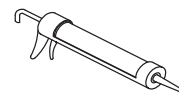

Caulk Gun

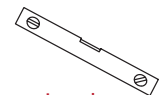

Level



Soft Cloth
or Blanket



Pliers



Electric Drill
with DrillBits



Philips
Screwdriver



Stud Finder



Hammer

Other tools may be required

DIMENSIONS & SPECIFICATIONS

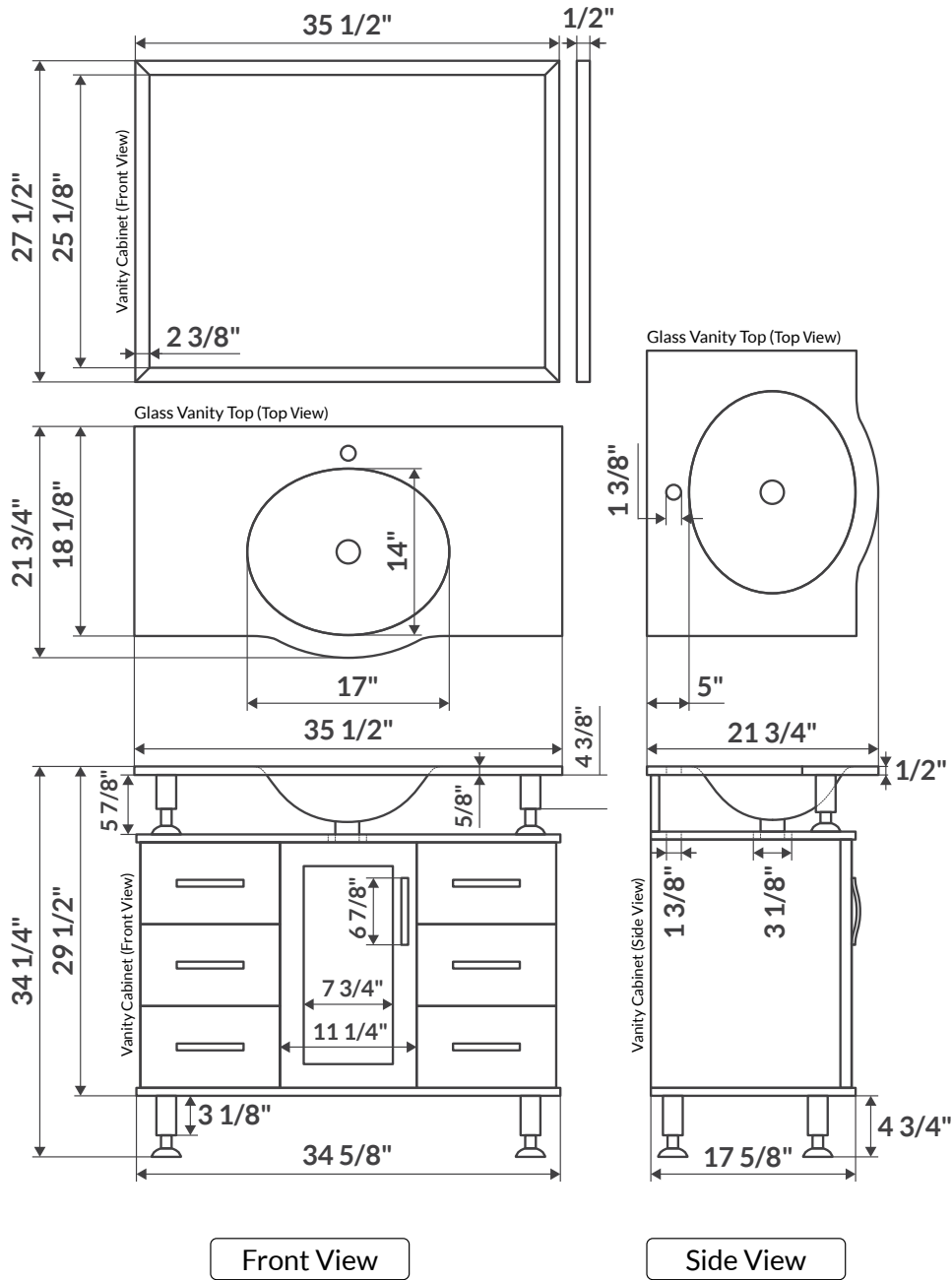

ATTENTION! Due to manufacturing process any dimensions may have a tolerance up to 3/8". All sizes are for reference only. It is highly recommended to pull all dimensions of actual model for installation and measuring purposes.

ATTENTION! If two or more vanity cabinets are installed next to each other there will be a visible seam between vanity tops and between vanity cabinets or between drawer base cabinets.

VANITY CABINET ASSEMBLY

INSTALL DOOR & DRAWER HANDLES

All LV1 vanity cabinets by LessCare® come pre-assembled. All door and drawer handles are installed from the inner side of the drawer to avoid damage during transportation. Open the doors and drawers to install the handles. Unscrew every handle and install them from the outer side of the doors and drawers. **See Figure 1**

Note: It is highly recommended not to use electric drill to avoid overtightening the screws during handle installation.

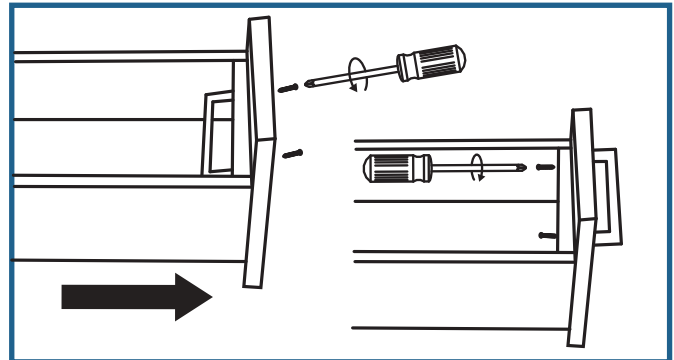

See Figure 1

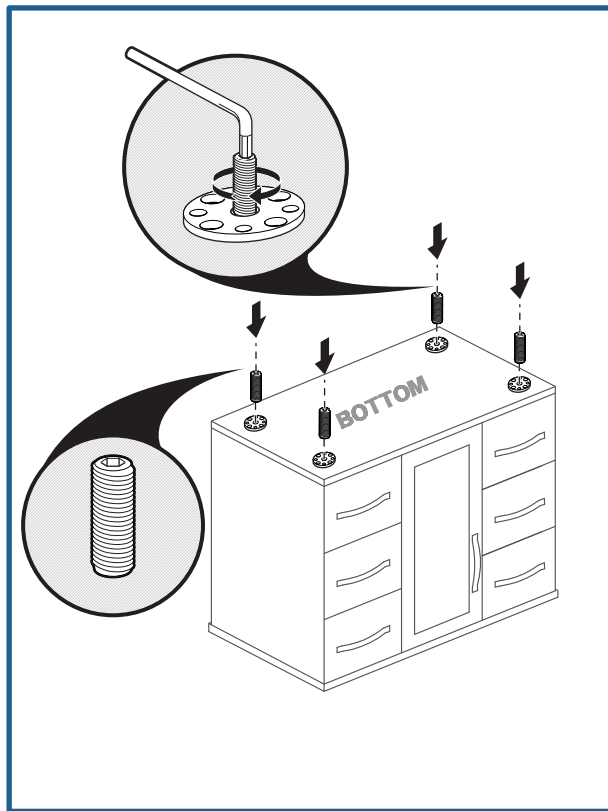

Figure 2

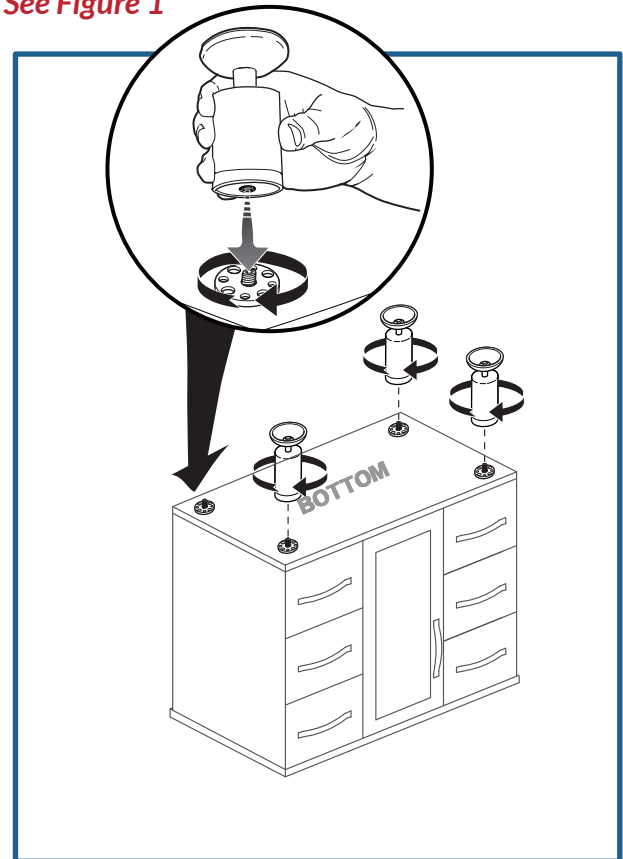

Figure 3

1

Attach turn the upside down Leg mounting plate is already pre-installed to the bottom of cabinet
Screw in leg mounting bolt

See Figure 2

2

Attach each mounting leg to the bottom of cabinet by screwing in the leg on top of the leg mounting bolt

See Figure 3

MIRROR INSTALLATION

Using a tape measure find a length of the vanity top and divide it by 2. The result of the division will be a center of the top. Using a tape measure find the center of the top and mark a dot on the wall just right above the top using a pencil. Using a level tool find a location of a second dot to draw a vertical line that will serve as installation center for the mirror.

Measure the distance between installation brackets of the mirror and divide it by 2. The result of the division will be a distance between the drawn center line and center of a drilled hole. Mark a center of the first hole and using a level find and mark a location for a second hole. Using an electric drill make the holes.

See Figure 4

Apply a silicone inside each hole. Insert wall anchors (a hammer may be needed if the holes are too tight.) Using a Philips Screwdriver insert the mounting screws into the wall anchors (do not screw in completely as the brackets of the mirror must hang on top of the screws.) Align the mirror with the wall and carefully hang the mirror on the screws. Both screw heads must be inserted into the brackets on the mirror during hanging process. Make sure that the mirror is secured safely on the wall. **See Figure 5**

Note: If the brackets can not reach the screws or the mirror is loose after hanging you need to adjust the screws using the Philips Screwdriver.

IMPORTANT! Using a stud finder locate wooden studs. Screws for mounting mirror must be installed in the wooden studs to support weight of the mirror.

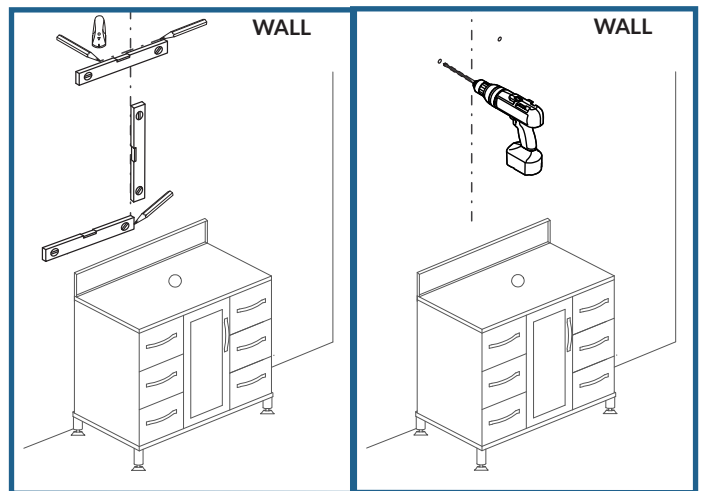

Figure 4

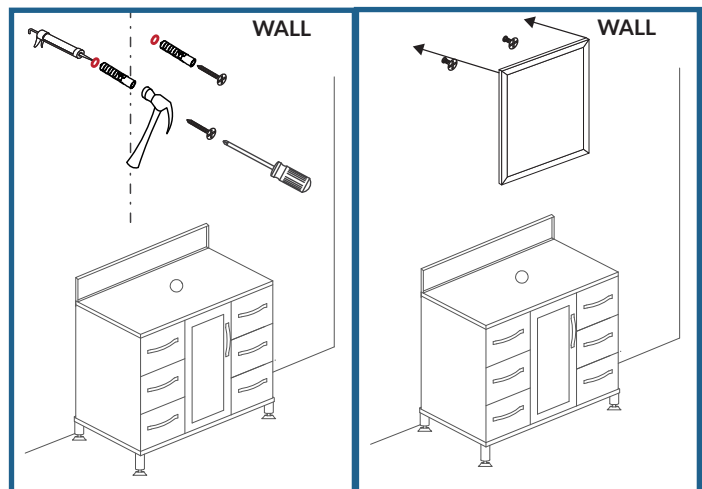
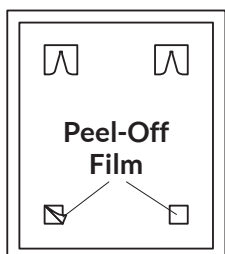

Figure 5



Mirror Back View

IMPORTANT:

At the bottom of the back side of the mirror there are two foam blocks with adhesive surface covered by a film. Remove the film before hanging the mirror. These blocks will stick to the wall for extra support, leveling, and preventing from moving.

VANITY CABINET ASSEMBLY

Prior to installation of the glass vanity sink you must apply a silicone layer by a perimeter of the vanity base cabinet and carefully lay down the vanity sink on the vanity cabinet.

See Figure 6

Note (single vanity sink cabinet installation):

Apply a silicone layer on the back side of the vanity top that will be adjacent to the wall.

Apply the glass top leg on the vanity.

Apply a silicone layer on the end of the sink. Carefully lay down the sink on the vanity. Once the sink is on vanity apply a light pressure to fixate the sink on the top.

Allow the silicone dry for 48 hours prior to the first use of the vanity cabinet.

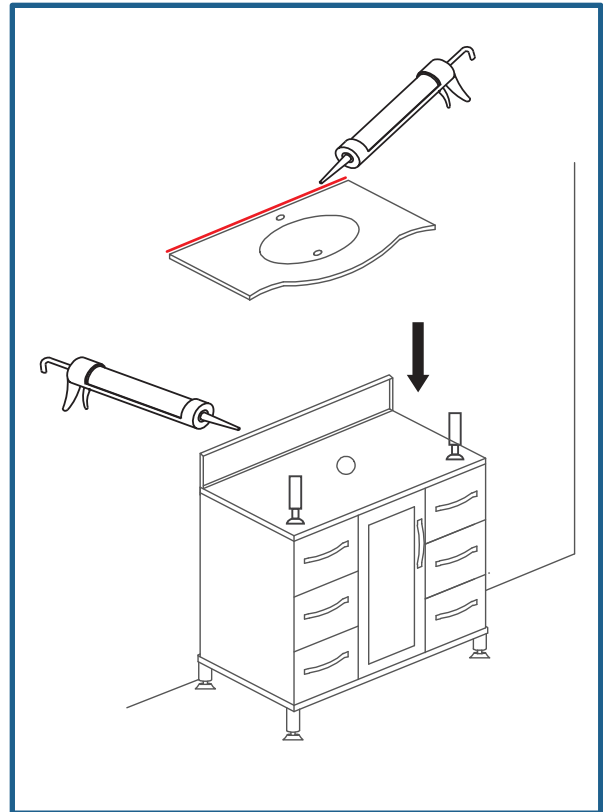

Figure 6

Retain these installation instructions
for future reference!



Thank you for using
LessCare products!